

3-26-2005

## Integrating the Supply Chain with RFID: A Technical and Business Analysis

Zaheeruddin Asif

*Temple University, zaheeruddin.asif@temple.edu*

Munir Mandviwalla

*Temple University*

Follow this and additional works at: <https://aisel.aisnet.org/cais>

---

### Recommended Citation

Asif, Zaheeruddin and Mandviwalla, Munir (2005) "Integrating the Supply Chain with RFID: A Technical and Business Analysis," *Communications of the Association for Information Systems*: Vol. 15 , Article 24.

DOI: 10.17705/1CAIS.01524

Available at: <https://aisel.aisnet.org/cais/vol15/iss1/24>

This material is brought to you by the AIS Journals at AIS Electronic Library (AISeL). It has been accepted for inclusion in Communications of the Association for Information Systems by an authorized administrator of AIS Electronic Library (AISeL). For more information, please contact [elibrary@aisnet.org](mailto:elibrary@aisnet.org).



## INTEGRATING THE SUPPLY CHAIN WITH RFID: A TECHNICAL AND BUSINESS ANALYSIS

Zaheeruddin Asif  
Munir Mandviwalla  
Fox School of Business and Management  
Temple University  
[munir.mandviwalla@temple.edu](mailto:munir.mandviwalla@temple.edu)

### ABSTRACT

This paper presents an in-depth analysis of the technical and business implications of adopting Radio Frequency Identification (RFID) in organizational settings. The year 2004 marked a significant shift toward adopting RFID because of mandates by large retailers and government organizations. The use of RFID technology is expected to increase rapidly in the next few years. At present, however, initial barriers against widespread adoption include standards, interoperability, costs, forward compatibility, and lack of familiarity. This paper describes basic components of an RFID system including tags, readers, and antennas and how they work together using an integrated supply chain model. Our analysis suggests that business needs to overcome human resource scarcity, security, legal and financial challenges and make informed decision regarding standards and process reengineering. The technology is not fully mature and suffers from issues of attenuation and interference. A laboratory experiment conducted by the authors shows that the middleware is not yet at a “plug-and-play” stage, which means that initial adopters need to spend considerable effort to integrate RFID into their existing business processes. Appendices contain a glossary of common RFID terms, a list of RFID vendors and detailed findings of the laboratory experiment.

**KEYWORDS:** RFID, RFID technology, supply chain, RFID applications, business implications of technology, technology adoption

### I. INTRODUCTION

RFID (Radio Frequency Identification) is an emerging technology intended to complement or replace traditional barcode technology to identify, track, and trace items automatically. RFID is claimed to add intelligence to and to minimize human intervention in the item identification process by using electronic tags. The tags are significantly different from printed barcodes in their capacity to hold data, the range at which the tags can be read, and the absence of line-of-sight constraints.

RFID dates back to the 1940's when the British Air Force used RFID-like technology in World War II to distinguish between enemy and friendly aircraft. The theory of RFID was first explained in 1948 in a conference paper entitled “Communication by Means of Reflected Power” [Stockman, 1948]. The first patent for RFID was filed by Charles Walton in 1973 [Takahashi, 2004].

Perhaps the most familiar application of RFID is the automated toll-paying systems along East Coast and West Coast toll roads. However, the cost equation only recently became favorable for widespread adoption. The drive toward adopting RFID is being further enhanced by mandates from large retailers such as Wal-Mart and Target, and the US Department of Defense, who require all suppliers to implement this technology within the next few years. Initial savings and benefits estimated to accrue to Wal-Mart include [ROI-Watch, 2003]:

- \$6.7 Billion in reduced labor costs (no bar-code scanning required)
- \$600 Million in out-of-stock supply chain cost reduction
- \$575 Million in theft reduction
- \$300 Million in improved tracking through warehousing and distribution centers
- \$180 Million in reduced inventory holding and carrying costs

The U.S. Department of Defense, with 43,000 suppliers is planning to overhaul its entire supply chain because it believes that RFID will reduce losses due to lack of information. The General Accounting Office substantiated the need in a December 2003 report that showed a \$ 1.2 billion discrepancy between the material shipped and the material received in Iraq by the Army [Tegtmeier, 2004].

Among organizations, a supply network characterized by rich information exchange, which can be enabled by RFID, increases the feasibility of implementing alliances of firms that exchange information to coordinate production and distribution, outsource functions and services, and partner with suppliers and intermediaries [Lee, Padmanabhan et al., 1997; Straub, Rai et al., 2004]. Without RFID it will likely be too difficult to extract, share, coordinate, and control information as products work their way through the value chain of one firm to another. It is easy enough to create a futuristic vision of networks of organizations, but real firms specialize in one area, delivery trucks travel only half-full, and demand forecasting is messy; the logistics of moving goods is a difficult, error-prone, and information-poor process. An RFID-enabled supply chain may, for the first time, provide firms with the data and tools needed to analyze and “rationalize” their supply processes fully.

## TAGS

The key component of an RFID system is the tag itself. Tags come in a large variety of forms and functional characteristics (Section II). One useful way of classifying tags is to divide them into active and passive classes.

- active tags whose read/write range is longer and
- passive tags with shorter range.

However, passive tags are much cheaper than the active tags and are therefore more widely used. Tags represent a big portion of cost in any RFID implementation. One tag may cost anywhere between 0.2 and 10 dollars depending on factors like form, operating frequency, data capacity, range, presence or absence of a microchip, and read/write memory.

Ordinary barcode labels cost less than a cent on average. However, they easily become soiled, dirty, torn, marked over, hidden in frost, and need line-of-sight orientation. Correct orientation requires extra human intervention to make the barcode readable. RFID tags do not suffer from these disadvantages. In addition, unique features such as ability to be written to and long range potentially can spawn a whole new set of applications and radically improve the performance of applications such as inventory management and supply chain management. The possibility of automatically detecting and tracking items promises substantial reductions in costs and time needed for inventory management. In short, applications built around this technology can provide both operational and strategic benefits to adopting organizations.

## CHALLENGES

Yet many technical and business challenges lie ahead before RFID becomes commonplace. Technical issues include problems of interference, security and accuracy, while business issues pertain to such problems as cost and lack of standards. As of December 2004, three groups offered competing proposals for setting up RFID standards to EPCglobal, the standards body for auto-identification. At this juncture companies need to formulate strategies for short-term adoption and evaluation as well as long-term phased integration of RFID into their business models.

## ORGANIZATION OF THIS PAPER

In the next section we describe the essentials of RFID (the basic hardware, software and infrastructure components that make up an RFID system). With the help of a model we explain how these components work together. In section III we present a classification framework that may be used to categorize RFID applications. In this section, some applications are discussed to give the reader an idea about the diversity of RFID applications and how the framework may be used to chart this diversity. In section IV, various business, technical and strategic challenges such as costs, issues regarding standards, security, legislative concerns, business process redesign, and strategic alignment are discussed in detail. Section V provides a brief checklist for RFID adoption. In section VI we turn to the research implications of RFID, issues such as enterprise integration, supply chain management, data warehousing, the role of standards in IT adoption, and RFID ROI are dealt with in detail. The last section presents conclusions.

## II. RFID ESSENTIALS

This section describes the basic components of an RFID system. Note that the exact configuration of a particular deployment depends on the vendor, system integrator, and the application.

An RFID system includes:

- Transponders (Tags) that allow items to be identified.
- Antennas and Readers/writers that allow tags to be interrogated and to respond.
- Software that controls the RFID equipment, manages the data and interfaces with enterprise applications.

### TRANSPONDERS (A.K.A TAGS.)

Transponders are the distinguishing feature of an RFID system. Transponders are the 'labels' that are attached to objects to be identified. Due to their wide-spread use in supply chain operations, they are commonly known as tags. These microchip-based tags with a tiny antenna attached to them (Figure 1) can hold up to 10 Kbits of data. The data stored can include product identification, expiration, warranty, handling and storage instructions, and service history.



Source: Alien Technologies

Figure 1. A Tag

Instead of visible light used in ordinary bar code labels, these tags use radio waves to communicate with the readers. To produce radio waves tags require some source of energy to power its electronics. Active tags use a tiny battery, a microchip, and a tiny antenna built into them (Figure 2).

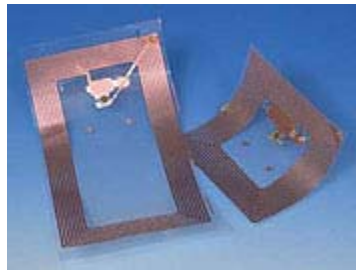

Source: Texas Instruments

Figure 2. Active Tag

Compared to passive tags, active tags are more expensive (typically more than US\$20 each) but they provide a longer read/write range (up to a 100 feet or more), offer greater functionality, and their battery life is up to a year.

'Passive' tags, such as the one shown in Figure 3, are relatively inexpensive (may cost anywhere from 20 cents to several dollars) because they do not contain a battery within them; instead they draw power from the reader's radio signals that induce a current in the tag's antenna using either inductive coupling or electromagnetic capture. This power is used both for chip operation and for communication. Passive tags essentially reflect back the radio waves from the reader in order to communicate – a phenomenon sometimes known as [backscatter](#). However, their signal range is very low, usually less than 10 feet. Semi-passive tags fall somewhere between the two; they use a battery for a chip's standby operation but draw energy from the reader during active communication sessions.

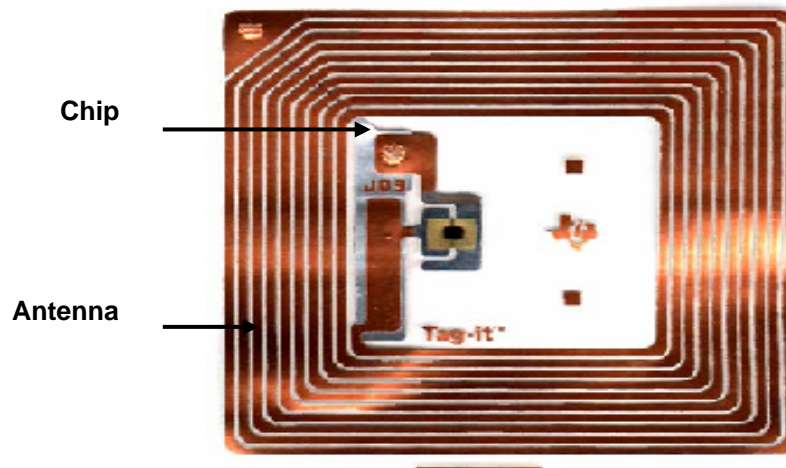

Source: Texas Instruments

Figure 3. Passive Tag

[Chipless tags](#), on the other hand, may be cheapest of all because they do not contain silicon-based chips and memory. They can be produced for about a cent each for bulk quantities of millions. They offer several advantages over other types such as thin physical profile, less sensitivity to interference, and operation over a wider range of temperature. Since their physical

profile is very thin they could be embedded in paper labels, producing what are commonly known as smart labels. Several technologies are used for chipless tags, including inductive resonance and magnetic resonance. The former type uses transistor-less circuits made up of conductive polymers as a substitute for silicon-based micro-chips. Magnetic resonance tags use special kinds of microscopic magnetic particles that emit signature radio waves when bombarded with electromagnetic radiation by the reader. The reader picks up the radio emission from these particles and converts the signal into bits. This kind of tag can be used for authenticating sensitive documents like intelligence reports and currency notes.

On the other hand, their storage capacity is still quite low, typically 24 to 32 bits compared to up to several kilobits for chip-based tags. Their operating range is only about one meter. Being without silicon memory, they can not store unique serial numbers. That is why they are not suitable for supply chain applications. Chipless tags are modified versions of RF-based electronic article surveillance (EAS) tags that contain only a single inductance-capacitance circuit usually printed with conducting ink. EAS tags can only indicate their presence or absence by reflecting back radio waves beamed at them, essentially exhibiting a one-bit storage capacity. Chipless tags achieve multi-bit capability by using multiple circuits that are layered on top of one another. At present, they represent about 2.5 % of RFID market, but this share is expected to grow to 30% in the next decade [Harrop and Das, 2004].

The tags can also be distinguished from each other based on their intended use, size, and shape and whether or not data can be written to them. Active tags are usually bigger than passive tags because they are usually meant for extended reuse and rugged environments; for example to be mounted on ship containers or railway carriages. Read-only tags are less expensive than read-write tags because they do not require rewritable memory used in read-write tags, such as [EPROM](#), [EEPROM](#), or flash memory.



Source: Texas Instruments

Figure 4 Some Low-Frequency Tags

The operating [frequency](#) of radio waves employed also varies. Low-frequency RFID tags (Figure 4) operate at 125 to 134 kHz, for US and international use. High-frequency systems use 13.56 MHz. Frequencies of 866 to 960 MHz are used in UHF (ultra-high-frequency) systems, while microwave systems operate at 2.4 to 5.8 GHz [Dipert, 2004].

Since metals and liquids absorb radio waves, presence of such items in the environment adversely affect the performance of RFID devices. High-frequency waves are absorbed more readily and are thus more susceptible to attenuation than low-frequency ones. Therefore low-frequency tags are more suitable for high water content products such as fruits, or those packaged in tin cans.



Table 1 provides approximate values for the characteristics of high and low-frequency tags. The exact values depend upon a combination of factors such as tag type – active or passive, presence of radio noise or radio absorbing materials in the environment, and the size and gain of antenna and the type of reader.

Table 1. Characteristics of Active and Passive Tags

Tag Frequency	General Tag Type	Approximate			
		Range	Transmission Rates	Power Consumption	Cost
Low	Passive	< 1.0 m	1 – 2 kb/s	20 $\mu$ W	\$0.2 - \$1.0
High		1.5 m	10 – 20 kb/s	200 $\mu$ W	\$1.0 - \$10
Ultra High	Active	10 – 30 m 20 – 100 m*	40 – 120 kb/s	0.25 – 1.0 W	\$10 - \$30

\* with battery-powered tags

In general, the relative values for various characteristics of tags operating at different frequencies can be summarized as shown in Table 2.

Table 2. A Comparison of High and Low Frequency Tags

Tag Frequency	Relative Range	Transmission Rates	Power Consumption	Relative Cost	Environmental Susceptibility
Low	Shorter	Lower	Lower	Lower	Lower
High	Longer	Higher	Higher	Higher	Higher

RFID tags come in many forms, including glass capsules, disks, cylindrical tags, wedge-shaped tags, smart cards, and keychain fobs, and can range from a few square millimeters to up to a few inches long (Figure 5). Different form factors are suitable for different applications. For example, small glass capsules (2mm by 1cm) may be injected directly under the skin through large-gauge hypodermic needles to tag cattle, as glass is non-reactive and non-biodegradable [Troyk, 1999]. Similarly, different operating frequencies are suitable for different purposes and there is no ideal frequency for all applications. For instance, while higher frequencies may be needed in the shipping industry for longer range, low frequencies may be more suitable for access control purposes.



Source: [www.qualtechnetworks.com](http://www.qualtechnetworks.com)

Figure 5. Examples of Tags

## ANTENNAS

Antennas also come in a diverse range of form and technical factors (Figure 6). They are used in both the tags and the reader (see next subsection). The size could vary from under a square centimeter to several square meters. Technically speaking, UHF reader antennas can be classified as circular-polarized or linear-polarized antenna. The former emit and receive radio waves from all directions, while the later work best in one particular direction (Figure 6). Therefore circular-polarized antennas are less sensitive to transmitter - receiver orientation and work better 'around corners'. However, the operating range of a linear-polarized antenna is more than that of a circular-polarized antenna [Intermec, 2004]. The operating range of an antenna also depends upon its [gain](#) which is its ability to focus radio waves. Higher gain antennas can work at a longer range than the lower gain counterparts. However, there is always a tradeoff between gain and coverage area (a.k.a. [reader field](#)). Therefore, omni-directional antennas have smaller gain and the ones that cover a narrower area will have a higher gain (Figure 7).

When a tag communicates with an antenna, the radio frequency portion of the circuit between the tag and the antenna is called the air interface. This radio communication takes place under a certain set of rules called [air interface protocol](#). Propriety protocols may cause interoperability problems with equipment from different vendors.

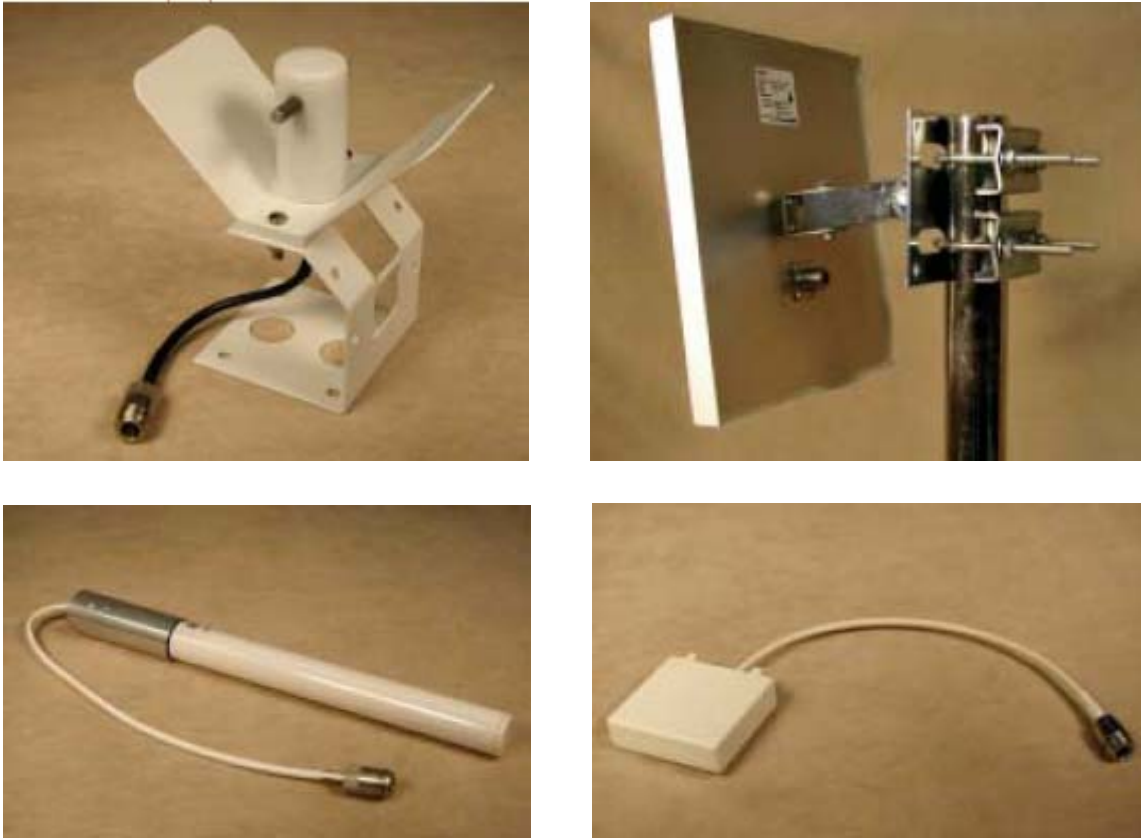

[clockwise from top right: Flat panel, Dual flat panel, Omni, and Corner: Intermec, 2004]

Figure 6. Types of Antenna



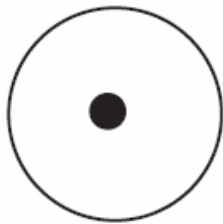

Low-Gain High-Coverage Antenna



High-Gain Low-Coverage Antenna

Figure 7. Antennas

In the US, the use of antennas is controlled by the [FCC](#) and in Europe by the [ETSI](#). These regulatory bodies impose upper limits on the total output power that can be transmitted by the antennas and also license different frequency bands for various purposes. Although, high frequency RFID equipment work in [ISM](#) (Industrial Scientific Medical ) bands that can be used without license (provided the output power does not exceed 1 watt), all antennas must be approved and certified before they can be used. Users need not worry about this limitation because vendors in the US and elsewhere are not permitted to sell equipment that operates beyond legal limits.

### READERS (A.K.A. INTERROGATORS)

Readers read or interrogate the tags. In reading, the signal is sent out continually by the (active) tag whereas in interrogation, the reader sends a signal to the tag and listens. To read passive tags, the reader sends radio waves to them, which energize them and they start broadcasting their data. The reader reads all the tags within its read range in a quick succession. This automatic process reduces read times. In a field test, Marks & Spencer, UK, tagged 3.5 million bins with RFID tags. While it used to take 17.4 minutes to read 25 trays with bar codes, on 36 dollies, RFID reduced that to just three minutes. This result was in an 83% reduction in reading time for each tagged dolly. [Wilding and Delgado, 2004].

If more than one tag is present within the range of a reader, various techniques are available to read them all sequentially. These techniques, grouped under the name of '[singulation](#)', identify individual tags by allowing only the tags with a specific serial numbers to respond. The scheme where the reader controls the response timing of the tags is known as [reader talks first](#) method. Conversely, the scheme where tags start beaming their data as soon as they are energized by the reader is known as [tag talk first](#) method. The former method is more accurate but is slower compared to the latter.

Readers work at different frequencies, from a low of about 100 KHz to a high of about 5.8 GHz. The Tris S2000 reader used in our laboratory experiments (Appendix I) works at 134.2 kHz, which is at the low end. Read ranges for lower frequency systems are smaller but the systems are less susceptible to performance degradation in presence of metal or water in the environment.

The readers are usually connected to a remote antenna, some readers may work with multiple antennas and use a device [multiplexer](#) [Acsis, 2004]. The readers also come in various form factors (Figure 8) ranging from huge frames that cover an entire entrance to the smallest reader which is the size of a quarter [SkyeTek, 2004].



Source: Psion

a. Handheld Reader,



Source: www.infineon.com

b. Large Frame Reader

Figure 8. Readers

Some readers can also write to the tags (Figure 9), which means that data on the read/write tags may be changed and added to in real time. This ability may prove helpful in situations where customer needs, business processes and standards may change any time. Read/write tags are reusable which reduces long term operating costs.



Source: www.rfidmicro.com

Figure 9. A Reader/Writer

'Smart tags' are a type of tag that are initially written to or 'programmed' by an 'RFID printer' (Figure 10) that can print bar codes on the labels while writing data to the chip embedded in the paper label.



Source: www.intermec.com

Figure 10 RFID Printer

## SOFTWARE

Software is the glue that integrates an RFID system. Again it depends upon the industry context, but usually a front end component manages the readers and the antennas and a middleware component routes this information to servers that run the backbone database applications. For example, in a manufacturing context, the enterprise software will need to be made aware of RFID at various levels depending on how far downstream into manufacturing and out into the supply chain RFID is implemented. The RFID Journal categorizes middleware technologies into three levels:

- (1) software applications which solve connectivity problems and monitoring in specific vertical industries,
- (2) application managers that connect disparate applications within an enterprise, and
- (3) device brokers that connect applications to devices like shop-floor machines and RFID readers [Rockwell, 2004].

The [Auto-ID Center](#) at MIT<sup>1</sup> developed a software program named 'Savant' to manage the enormous amount of data expected to be generated by RFID readers. In a typical manufacturing scenario, for example, readers will be picking up a continuous stream of tag data, which might contain errors such as duplicate reads and [phantom-reads](#). The job of a savant is to filter and manage this data and forward only clean data in order to avoid overwhelming enterprise applications

## AN INTEGRATED SUPPLY CHAIN MODEL

EPCglobal, an outgrowth of the earlier [Auto-ID Center](#), is one of two primary RFID standards-setting groups. It proposed an Internet-based supply chain model that is aimed at improving supply chain end-to-end visibility. A key component of the EPCglobal model is the Electronic Product Code or EPC. The manufacturer adds an RFID tag to every item of its product line. Each tag contains a unique [EPC](#) which is a 96-bit code proposed as a successor to Uniform Product Code or UPC. The structure of the Electronic Product Code is illustrated in Table 3.

<sup>1</sup> The Auto-ID Center at the Massachusetts Institute of Technology was a university research center sponsored by a consortium of firms in the RFID business. It was founded in 1999 and it transitioned into a non-profit firm called EPC Global in 2003.

Table 3. Structure of 96-bit EPC

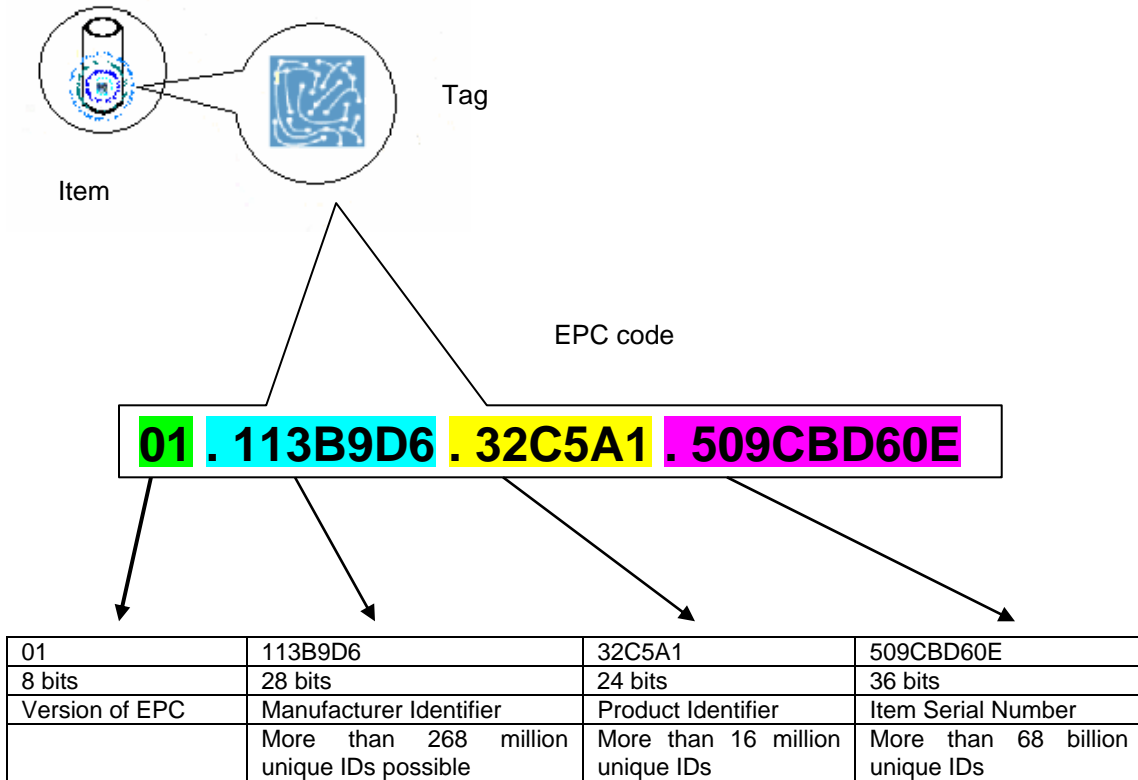

The supply chain is illustrated in Figure 11. Starting with point A, items are packed into cases and loaded onto palettes – both of which have their own tags to provide greater visibility and to keep accurate track of the movement of items. When the palettes leave the manufacturer, a reader at the loading dock quickly reads all item tags in a serial fashion. This information is sent to a computer running the Savant data management program to filter the data and selectively forward information to application programs in order to avoid choking the network. Savant retrieves detailed information about the items from a server holding this information on web pages written in Physical Markup Language (PML)<sup>2</sup>. The address of this web page is provided to the Savant program by an [Object Name Service](#) (ONS) server, whose databases are administered by third parties such as VeriSign. It is a service that locates detailed information about an object stored on the Internet using the object's unique [EPC](#). It works just like Domain Name Service (DNS) which locates web pages on the Internet using unique IP addresses. The [ONS](#) server maps an [EPC](#) to the address of the PML server, which is a dedicated computer configured to provide information to requesting clients and is maintained by the manufacturer.

The system now knows which items were produced where and when (point A in Figure 11). The same information is available to the distributor when the items arriving there are read by the readers on its side (point B in Figure 11). The items are quickly routed to the appropriate trucks (point C). As these items arrive at the retail outlet they are read by the receiving dock readers and its inventories are updated automatically (point D). Since the shelves at this outlet also have their own readers they can automatically raise replenishment orders. This sequence may be extended to the checkout counter when customers use RFID smart cards. They simply walk out the store

<sup>2</sup> PML is based on XML, a widely accepted eXtensible Markup Language.

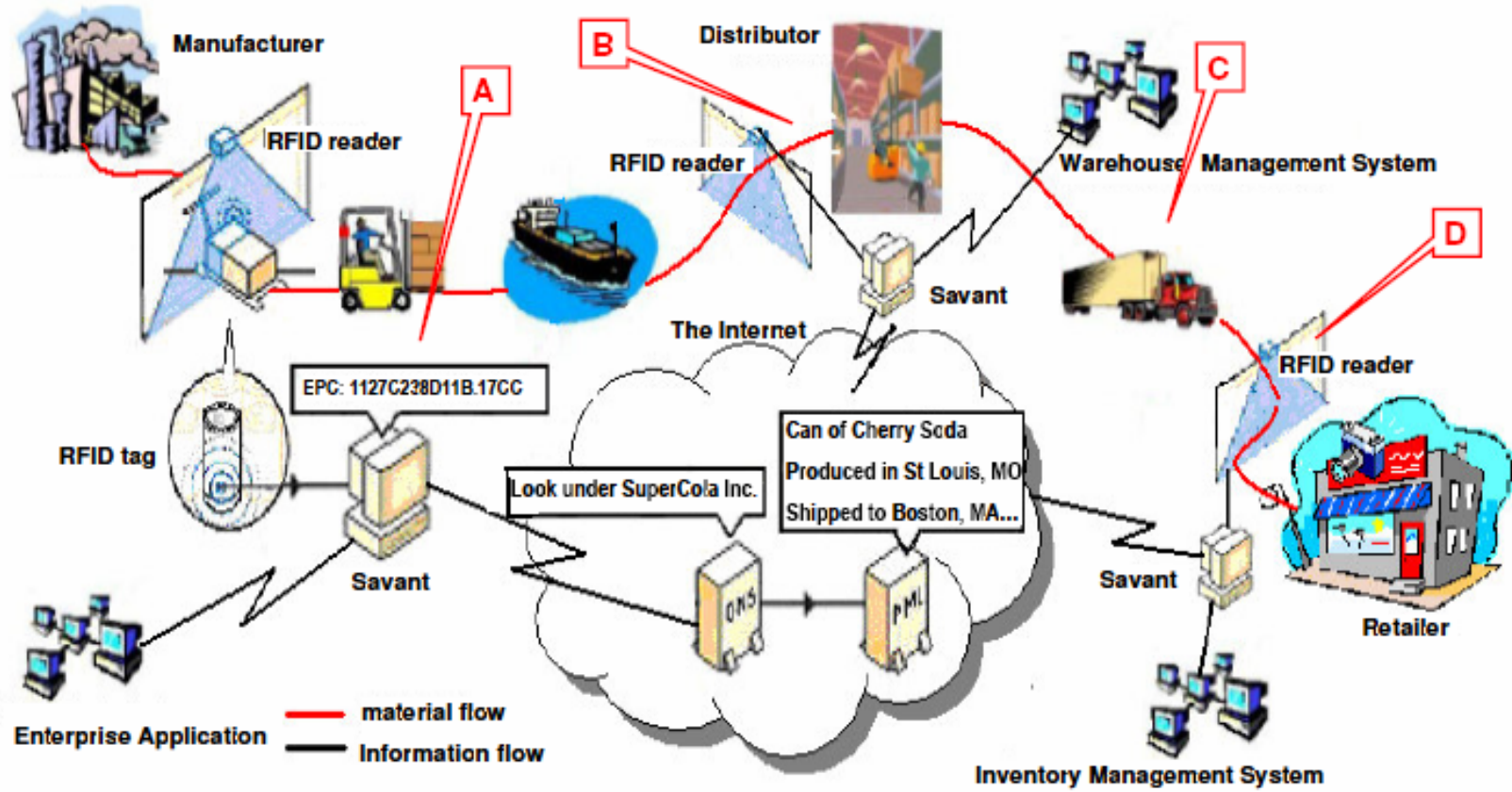

Figure 11. A Graphical Representation of EPC Global Supply-Chain Model

with their purchases. A reader built into the door recognizes the items in the cart and automatically debits the smart card.

### III. RFID APPLICATIONS FRAMEWORK

RFID applications are coming of age; numerous companies such as Procter & Gamble and Intel created posts of vice president for RFID research and development [Walker, 2004]. RFID is being used in an ever-increasing number of industries for such purposes as access control, package tracking, inventory management, e-government, baggage handling, fraud prevention and even school attendance. Broadly speaking, these applications may be classified according to the major purpose of deploying RFID,

- identification,
- authentication,
- location, or
- automatic data acquisition.

Authentication applications, such as smart cards for no contact, simple, automatic payments of small amounts such as highway tolls and cafeteria bills, usually assume the tag-holder to be a person rather than an object, whereas most supply chain applications assume that the tag-holder is an object. The supply chain applications are also different from people applications in that their major thrust is automatic data acquisition (ADA) rather than authentication. In most ADA applications, objects such as produced items, cases, and pallets are tracked automatically and the captured data is used to derive enterprise applications such as supply chain management systems, customer relation management systems, and enterprise resource planning systems.

Applications that require identification or ADA, such as RFID tags embedded in athletes' shoes to keep accurate timings at major athletics events, belong to the domain of 'ubiquitous computing' or 'the Internet of things'. This concept envisages a world where RFID tags are attached to a multitude of things that automatically communicate and coordinate with other networked intelligent devices to accomplish tasks that now require human intervention.

However, the effectiveness and the functionality of these applications will be largely dependent on the type of tag itself. While some tags offer longer read ranges, others can hold more data or are easier to manufacture hence less costly. Keeping the above discussion in mind, we divide RFID applications along three dimensions; major purpose, tag type and whether or not the 'labeled' object is a human. The framework is shown in Figure 12.



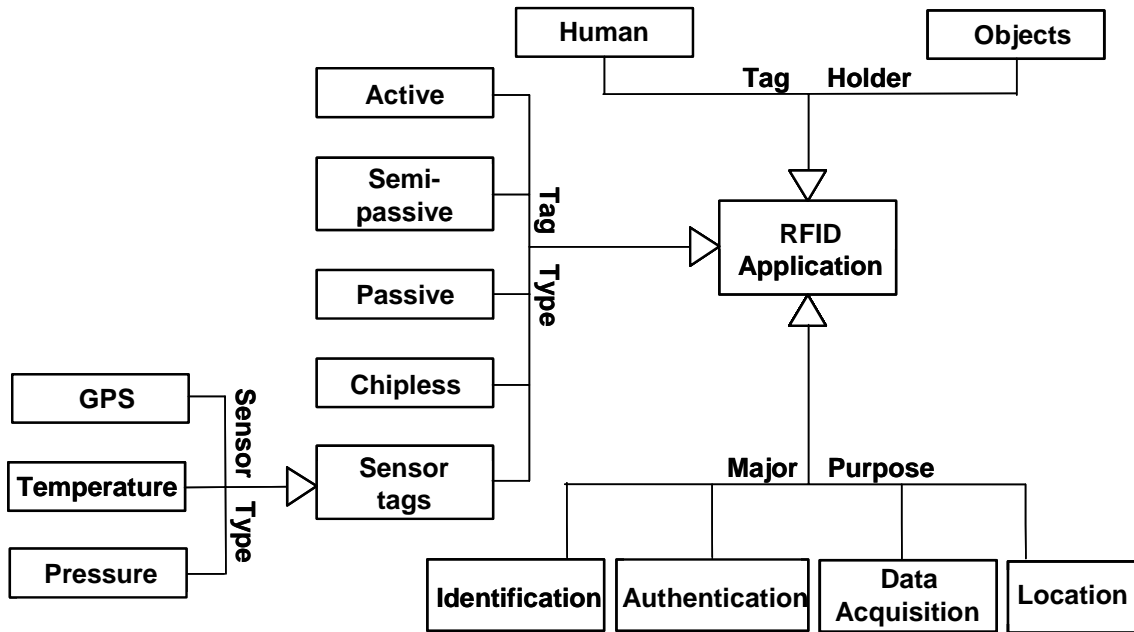

Figure12. A Framework for Classifying RFID Applications

The following is a small sample of RFID deployments that may be mapped to the framework:

### LEGOLAND

Legoland, an amusement park in Billund, Denmark, uses RFID technology to locate children who become separated from their parents.

*"If a child wearing a wireless-enabled wristband gets lost, parents can send a text message to an application called Kidspotter, which sends a return message stating the name and coordinates of the area of the park where the child is located" [Bednarz, 2004].*

This application may be mapped as a 'human, GPS Sensor, location' application.

### UNIVERSITY OF NEVADA LAS VEGAS

The University of Nevada, Las Vegas (UNLV) library reported saving \$40,000 in replacement costs for the 500 "lost" items it found after tagging its 600,000-plus book collection (Figure 13).



Source: [www.smartek.com.tr](http://www.smartek.com.tr)

Figure 13. University of Nevada Reno Library Application

They find that using RFID in libraries offers many advantages including self-checkout, self-check in, faster counter processing, automated sorting for re-shelving, better inventory management, in-

house usage monitoring and better collection development [Smart, 2004]. This application may be mapped as a 'passive tag, object, identification' application.

## **NASA**

Because Space Shuttle surfaces typically experience extremely high temperatures during reentry (1000s of degrees F) they require some form of a thermal protection system to prevent the vehicle from burning up. SRI International has developed a series of wireless sensors for monitoring these temperatures. The shuttle's surface is covered by 4-in-thick light-weight ceramic tiles that are attached to the underlying metal skin by a high temperature adhesive. However, sometimes hot gases penetrate the narrow gaps between the tiles and char the underlying adhesive. Hence all of these tiles must be inspected after each flight, and any tiles that are in danger of coming off must be replaced. This procedure is labor-intensive and time-consuming. Special RFID tags coupled with temperature sensors automate this job by signaling vulnerable tiles, eliminating the need to inspect all of them manually [Watters, Jayaweera et al., 2002].

## **COMBINING RFID WITH OTHER TECHNOLOGIES**

Additional benefits, such as supply chain visibility, may be gained when RFID is combined with complementary technologies like Global Positioning Systems [Pick, 2004] and Bluetooth. The case of DHL International, a third-party logistics provider, illustrates this point. DHL was able to monitor the movement of tagged Nokia phones as they traversed its distribution chain using both existing satellite systems and RFID [Walker, 2004].

Intel Corp. is implementing a new supply-chain management concept called "Inventory in Motion" where products are shipped before orders are received, using RFID and GPS technologies. The idea is to keep the pipeline filled and moving by shipping the products as soon as they are built. Once the order is received the products are diverted and redirected to the hub nearest to the customer. This system requires knowing exactly where the products are in the supply chain at any instant. RFID combined with GPS provides this knowledge. Intel keeps \$3.5 billion worth of inventory in its supply chain. It expects that improved visibility through RFID will save the firm millions of dollars and reduce current three-week delivery cycles to one week [Leach, 2004].

## **OTHER APPLICATIONS**

- RFID is being evaluated at Boston's Massachusetts General Hospital as a method of preventing transfusion of the wrong type of blood to patients [Bednarz, 2004].
- A German forestry company is using RFID for its log tracking application [Dines, 2004].
- To fight counterfeit products that are a common nuisance in the sports memorabilia industry, Emmitt Smith, an NFL superstar, is actively promoting the use of RFID for authenticating such products.
- In the livestock industry, the US Department of Agriculture commissioned an animal-identification system that would cost \$550 million and be completed in five-years [Bednarz, 2004].
- Michelin developed RFID-tagged tires. This innovation will allow Michelin to provide new value-added services such as roadside assistance for flat tires.
- Boeing and FedEx are actively evaluating the technology to facilitate aircraft maintenance processes by tagging parts with RFID chips that could hold not only the part number but also its installation date and manufacturer's code. This information could be used to access a global data base containing, for instance the part's complete life-cycle history [Tegtmeier, 2004].

## GROWTH RATES

IDC estimates that companies in the retail sector will spend nearly \$1.3 billion on RFID in their supply chain operations in 2008, compared to about \$91.5 million in 2003, a compound annual growth rate of 70 percent [Dines, 2004]. In a similar vein, the Wireless Data Research Group predicts that the global market for RFID will increase from \$1 billion in 2003 to \$3 billion in 2007. This increase in market size will come from applications like biometric identification, currency bills embedding chipless RFID tags, and item-level tagging in supply chains. Several kinds of organizations participate in the RFID market, including chip makers, system integrators, standards bodies, software writers, distributors, and of-course buyers (see Appendix II).

## IV. CHALLENGES AND IMPLICATIONS OF ADOPTING RFID

Overall, RFID is still financially, technically, and operationally infeasible for many businesses, especially those whose supply chain, manufacturing, and logistics processes are not rationalized and standardized. RFID does promise to solve many problems, yet at the same time it gives rise to a new set of potential problems and issues. In this section we highlight the key issues and implications associated with RFID adoption. The analysis is based on an extensive detailed literature review (see Bibliography), informal interviews with industry executives and vendors, the results of a panel discussion moderated by one of the authors [Mandviwalla, Confino et al., 2004], the results of an industry forum at Temple University involving key practitioners [Dignan, DeAlmo et al., 2004], and a laboratory experiment conducted at Temple University using current RFID technologies (Appendix I).

## HARDWARE AND SOFTWARE ARE A SIGNIFICANT EXPENDITURE

Although the prices of tags are falling, they represent significant cost. Passive tags may cost as little as 50 cents a piece (Table A-1), but only for bulk orders of a million or more tags [Walker, 2004]. A reader today costs \$1000 on average, yet some may cost as high as \$3000. Similarly, the cost of middleware varies. For instance, software from TagsWare cost about \$150 per antenna, while *RFID Accelerator* from ObjectStore starts at \$25,000 per CPU for development licenses [Dines, 2004]. Many applications (such as RFID-enabled warehouses) require specialized hardware such as RFID enabled fork-lifts, conveyor belts, inventory wands and sorting machines that add to the total [Walker, 2004]. By comparison, the conventional UPC barcode labels cost less than a cent on average and a barcode reader may cost less than \$200. In addition, barcodes do not need a special infrastructure.

In June of 2004, Wal-Mart announced a deadline of January 2005 for its top 100 suppliers to comply with its RFID mandate. That is, all cases and pallets traveling to a Wal-Mart facility will have an embedded RFID chip on them. For most suppliers, compliance with this mandate represents a significant expense. Overall, a large supplier could pay as much as \$9 million in the first year to comply with the mandate, with about 80 percent of that going to the electronic tags for upwards of 16 million cases and pallets [Rothfeder, 2004]. These figures from Forrester Research corroborate figures from AMR Research, which found that a conservative cost estimate for RFID implementation for a typical consumer packaged goods (CPG) manufacturer would be around \$13M to \$23M for shipping 50 million cases per year. The break down is given in Table 4.

Table 4. Costs for Shipping 50 Million Cases per Year

Tags and readers	\$5M to \$10M
System integration	\$3M to \$5M
Changes to existing supply chain applications	\$3M to \$5M
Storage and analytics of the large volumes of data.	\$2M to \$3M

The presence of products or packaging containing metal components that block the RFID signal, or conveyor belts made up of static producing nylon, or glass fiber that produces radio noise

may necessitate expensive changes in the physical infrastructure, increasing costs [Margulius, 2004].

### **TRAINING AND INTEGRATION**

Then there are costs for training. Forrester Research believes that optimizing processes, analyzing data, and training workers would cost companies more than the purchase of RFID technology [Walker, 2004]. RFID implementation will also require system integration. ABIresearch [2004] estimates RFID integration services revenue will surpass that of hardware by 2007. In addition, firms will incur costs from conversion (including consultants), reallocation of staff, additional hiring, and maintenance contracts [Smart, 2004]. Moreover, few personnel are experienced in RFID implementation. RFID is not yet a black box technology. Significant unanswered business process questions remain, which means that organizations will require personnel who can easily integrate technical and business challenges. Such integrative personnel are very hard to find and train.

### **ITEM VS. PALLET TAGGING**

Costs also depend upon the level of tagging. This choice makes item-level tagging versus pallet-level tagging an important business issue. At the item level, the number of tags required increases significantly along with an increase in amount of data generated by these additional tags. The cost of an individual tag also becomes crucial at the item level. There is little advantage of using tags that are as expensive as the item itself. The massive amount of data generated by item-level tagging also demands more sophisticated data filters and pipelines, which means more complex software layers and IT architecture. However, pallet-level tagging can not deliver all of the promised strategic benefits of RFID (Section VI).

### **STANDARDS**

Standards, which are an essential condition for interoperability and a driver for cost reductions, are not yet available. Currently, potential adopters of RFID face a chicken-and-egg dilemma: the prices of RFID equipment will not come down until it is adopted on a large scale. Another necessary condition for widespread adoption is the availability of pervasive standards. Early adopters of RFID will be wary of locking into the wrong standards, a potentially costly mistake both in terms of time and money [Jakovljevic, 2004]. Since contemporary supply chains span the globe, a consensus on international standards on frequencies is needed. Without such consensus it will be hard for an item using a specific country standard to traverse international supply chains.

### **SECURITY**

RFID tags contain limited computational resources. Therefore it is a challenge to design adequate cryptographic algorithms for data security [Sarma, Weis et al., 2002]. Another security challenge arises from the RFID environment connecting everything [Sarma et al. 2002]. Generally an RFID tag cannot identify authentic readers. Thus, it is possible in theory to read RFID tags without authorized physical access to the item. A scenario in which unscrupulous elements equipped with a powerful RFID reader drive down a road and make a list of all valuable items in a store is plausible.

### **PRIVACY AND LEGISLATION**

The biggest social issue centers on privacy concerns and threat of legislative oversight [Weis, Sarma et al., 2004]. This issue is much publicized with human rights groups raising their concerns about the prospects of human tagging. Artafact LLC and BIGresearch recently found that more than 60% of consumers who heard of RFID are very or somewhat concerned about the issues of privacy. The study was based on data collected from over 8000 consumers [Stegeman, 2004].

## ORGANIZATIONAL READINESS

Organizational structure and culture could impede smooth conversion to RFID in an organization. In a survey, a fear of change in the work environment was reported by almost 30% of respondents in the retail industry. Another 15% indicated that they feel animosity and internal distrust toward the IT department. Another cultural problem that appears in between 20 and 40 percent of all respondent categories is lack of an innovation culture [Abbott, 2004].

Organizations that already implemented supply chain initiatives such as vendor managed inventory (VMI)<sup>3</sup> will have already structured their processes and thus be better ready for RFID adoption. RFID is also relevant for organizations that are innovators in logistics and are using or experimenting with ideas such as replenishing stock in small incremental steps, using third party companies so that a truck can be completely filled even if it contains goods for competitors, using EDI to streamline paperwork, and composite distribution (where trucks can carry different kinds of loads – e.g., refrigerated vs. non-refrigerated). The reason is that complex logistics become feasible when it is easy to separate, sort, combine, and recombine packages. A RFID-enabled warehouse and truck will still “know” where the item or box is even if they are mixed with other items.

## ACCURACY

The accuracy of some readers is well below 90 percent [Rothfeder, 2004]. As pointed out in Section II, the range of most readers drop drastically if the tags are near metal or water because both these substances absorb radio waves. When more than one tag is present in the reader's range, tag collision can result in misreads or no reads. Since passive tags do not contain their own energy source, power consumption constraints are imposed on chip design. However, most of these problems are being solved. For example, efficient [anti-collision algorithms](#) are being developed, including TDMA (time-division-multiple-access), PJM (phase-jitter-modulation), FTDMA (frequency- and time-division-multiple-access) and eight-channel frequency-hopping algorithms [Dipert, 2004]. Progress is also being made in attempts to produce more power efficient chip designs and efficient error-correcting-code (ECC) schemes. Trolley Scan, a South African RFID company announced a UHF tag that consumes a quarter of energy used by conventional UHF tags [RFID-Journal, 2003].

## IMPLEMENTATION CHALLENGES

Implementing RFID is not as straight forward as implementing an off-the-shelf solution. Significant physical issues are involved in RFID implementation such as the details of antenna configuration, environmental conditions (including electromagnetic interference and issues of radiation absorption and obstruction), and interaction of product materials with tag materials. Other operational decisions include deciding the best location to place the tag on a case or pallet, the best locations for placing antennas, and locations within the value chain where data should be captured automatically. Thus, considerable engineering skills are required for RFID implementation. Similarly, no packaged solutions are available for software that will be needed to run the RFID infrastructure. Since every organization will use a unique process model, it may become necessary to develop low level software to handle data communications from the readers to enterprise applications. Configuring middleware may involve some programming. Specialized troubleshooting and maintenance skills may also be required to keep RFID hardware, software, and electrical and radio systems running.

## MANAGING PROJECTS: OPERATIONS TO MARKETING TO SYSTEMS

A key goal of supply chain management is greater speed and cost effectiveness [Lee, 2004]. Marketing tends to focus on pricing, customers, and product. An RFID-enabled integrated supply

<sup>3</sup> VMI is a practice in which the manufacturer manages the inventory for the retailer



chain will likely lead to greater speed and perhaps, over time, lower costs. However, speed and cost are the relatively easy and obvious goals of RFID enabling a supply chain. The more interesting and potentially strategic application may include integrating supply chain concepts with customer (marketing) strategies. For example, envision a customer walking into an electronics store to buy the latest hot cell phone. They find the shelf is empty; the sales person has no clue about new stock because the store just ran out this morning, and the opportunity to make a sale is lost as the customer walks out. An alternative scenario could include:

- The store shelf contains a small, inexpensive RFID reader and LCD display screen. As product stock runs out, the display screen lists the delivery date and time for new inventory. The customer may now conceivably come back to the store to buy the product.
- Alternatively, the customer is offered a small price discount for placing an order now for the product. If the demand for the product is high, and potential new inventory options are low, perhaps the price shown is higher (pricing is displayed on easily modifiable inexpensive networked LCD screens).
- If the customer chooses to order the item, the information is conveyed instantly to the RFID-enabled distribution center where the truck is being packed and the item is diverted to a shipping center for direct delivery to the customer.
- If the customer is not interested in formally ordering, their interest is captured and transmitted further upstream to be used for refining demand models.

Regardless of the feasibility of the above ideas, the key point is that to take complete advantage of an RFID-enabled supply chain, the manager must now integrate traditional supply chain concepts of speed and cost with marketing concepts of pricing, customer relationships, and product customization. This approach requires a systems perspective in which products, supply chains, and customer relationships are seen as part of a larger whole and all aspects of the value chain are open to modification and change. The information systems orientation of understanding process flows may be key to fully realizing the benefits of an RFID enabled supply chain. These arguments imply that organizations starting internal RFID projects should include distribution, marketing, and information systems personnel in teams, and should use a systems perspective on planning and implementation.

## INFORMATION SHARING AND CHANNEL ALIGNMENT

Lee et al. [1997] propose information sharing, channel alignment, and operational efficiency as strategies to counteract the “bullwhip effect”, a phenomenon in which distorted information from one end of the supply chain can lead to excessive fluctuation in demand projections further up the chain. Information sharing means providing timely demand information upstream from a downstream site so that forecasts and orders are more accurate, while channel alignment is the coordination of pricing, transportation, planning, and ownership between the various actors in a supply chain. An RFID-enabled supply chain can make it much easier to capture and share retail data. Tag readers on the retail shelf, warehouse, and trucks can pinpoint real time sales, stock, and deliveries. However, organizations will need to establish appropriate control policies for how the sharing and alignment will occur. Without such control, an RFID-enabled supply may end up inundating the chain with too much information.

## V. A CHECKLIST FOR ADOPTION

Like any other information technology, RFID raises a new set of tasks: setting goals, evaluating other installations, selecting a vendor, planning conversion, managing the actual conversion, and assessing the results [Smart, 2004]. Companies considering RFID will need to plan for additional network infrastructure, storage capacity, RFID printers and readers, and additional data generated by millions of new tags flowing in its supply chain. Since RFID is bound to change



existing processes it is advisable to do pilot testing prior to full fledged implementation [Walker, 2004]. It should also be realized that it is not the deployment of tags and readers by itself that will push companies ahead of their competitors. Rather it is the way an organization uses the fine-grained and real-time data to change and improve its business processes that will determine the extent of strategic benefit to be obtained from RFID [Dines, 2004]. Table 5 provides a checklist [adapted from sun.com, 2003] of steps and issues to consider during adoption.

Table 5. Checklist for Adoption

Implementation Considerations	Implementation Questions
<ol style="list-style-type: none"> <li>1. Evaluate the business case.</li> <li>2. Develop clear project plan.</li> <li>3. Master the physics of RFID.</li> <li>4. Plan for extensive remote maintenance.</li> <li>5. Carefully manage your network's capacity.</li> <li>6. Be aware of RFID risks.</li> <li>7. Keep process and technical design flexible.</li> <li>8. Take effective security measures.</li> <li>9. Consider privacy issues.</li> <li>10. Evaluate strategic implications.</li> </ol>	<ul style="list-style-type: none"> <li>• Do propriety protocols, technical specifications, and maintenance contracts restrict your capability to mix and match components from multiple sources?</li> <li>• How open is the proposed solution?</li> <li>• How does it fare on the interoperability dimension?</li> <li>• Since RFID will generate enormous amounts of data, can the solution handle present volumes and could it scale up for future requirements.</li> </ul>

source: sun.com[2003]

## VI. RESEARCH IMPLICATIONS

The sharp rise in media attention toward RFID coincided with the initial optimism provided by consultants and vendors. However, this euphoria was followed by pessimistic assessments by neutral observers and a reluctance by small organizations to adopt RFID. This situation is representative of the path followed by various IT innovations that provides an opportunity for conducting research.

### RFID AND THE ROLE OF IS

Little research is published on RFID in IS. Given the system and process impact of RFID on the supply chain, it seems at the surface to be a good fit with the traditional skills of an IS researcher and the problems posed by the technology. For example, [Janz, Pitts et al., 2005] provide an interesting case study on RFID implementation in the healthcare industry. They conclude that traditional IS concepts such as project management and systems development techniques are still relevant but that RFID adds new wrinkles such as the need to be more sophisticated in data management and to be able to model RFID enabled processes better. These new wrinkles provide an important basis for future IS-led research.

### ADOPTION OF TECHNOLOGY

Is it possible to mandate and control the introduction of new technologies? Wal-Mart and the DoD with their mandates required suppliers to adopt a new technology. Such an approach, if successful, may throw into question the traditional adoption and diffusion models which are premised on an assumption that technology users enjoy freedom of choice. The historical parallel is the experience of the automotive industry with EDI adoption. Can the insights from EDI adoption and all the missteps assist researchers and practitioners with RFID implementation? The Jan 1, 2005 Wal-Mart deadline passed and fell short of widespread implementation. Still the deadline did trail blaze a new "short-circuited" method of large scale adoption of new technologies. It would be interesting to study the impact on conventional adoption plans.

## **ROLE OF STANDARDS**

The role of standards and the process of adopting standards are currently being studied [Hovav, Patnayakuni et al., 2004]. The intensity of interest in RFID standards, the assumptions in industry that adoption will be rapid, and will immediately create financial impacts that will lead to immediate consolidation of firms, may provide researchers with a vivid case of how standards can change (or not) an entire industry.

## **DATA WAREHOUSING**

Successful RFID applications will potentially create terabytes of data. Quantitative changes of this magnitude invariably produce qualitative changes as well. In the case of RFID, such data volumes will impose severe strains on existing data management and storage structures and strategies. A stream of research on managing and storing large data sets is already underway in computer science (e.g., ACM international workshop on Data warehousing and OLAP), however, RFID may create new challenges because of the speed at which data is generated. Envisioning new ways to manage, use, and control RFID-generated data could provide a new role for IS researchers.

## **ENTERPRISE INTEGRATION**

Enterprise integration focuses on seamless flow of data from one application to another and from one part of an organization to another. RFID brings a new opportunity to explore the ramifications of how data moves through the “bloodstream” of an organization. Rigorous research is needed to identify and evaluate the issues and benefits afforded by the additional visibility of data flows within an organization provided by RFID. By making the use and flows of data more visible, it may be possible to map areas where integration is most needed or most beneficial.

## **NEW RESEARCH-BASED PROTOTYPE APPLICATIONS**

The availability of RFID generated sales and transaction data represent an opportunity for both researchers and vendors to envision new information visualization, gathering, analysis, and decision making tools. Academics long speculated about what could be done in an organization if only such and such data were available. RFID applications should bring us much closer to this reality. We may therefore need research-based prototypes that demonstrate new forms of decision making tools and related technologies.

## **SUPPLY CHAINS**

An RFID enabled supply chain in one sense will, for first time, allow information and product flows to inter-relate as the “product” moves through raw material, manufacturing, distribution, retailing, consumption, waste, and even recycling. Imagine, for example, a RFID-enabled silicon chip that is part of an electronics component as it makes the journey. What stories that chip could tell! The RFID tag on that chip will now allow the product to carry with it information, information that in the past was always considered to be a separate independent flow in traditional supply chain conceptions. Will widespread adoption of RFID require re-examination of what we think of as a supply chain?

As discussed in Section IV, Lee, Padmanabhan et al., [1997] propose information sharing, channel alignment, and operational efficiency as strategies to counteract the “bullwhip effect.” In this context, RFID may be relevant both as a research tool and as a mechanism to implement the proposed remedies.

Although various algorithmic solutions are proposed to model the bullwhip effect, to our knowledge no systemic “information and product flow” analysis describes how products move through the supply chain. It may be interesting to analyze the data from pilot projects in large complex organizations and completely map the flow of information (i.e., the information embedded in the tags and associated information) and how it is used. This kind of analysis may

provide new insights as well as empirically confirm the causes for the bullwhip effect and the efficacy of the proposed strategies.

Rai, Patnayakuni et al., [2004] note that little formal research is published by the IS community on supply chain management. They provide a theoretical basis to understand the impact of supply chain integration. Their research model maps IT integration capabilities into supply chain process integration capabilities which then lead to specific firm performance variables. Supply chain process integration is based on information, physical, and financial flow integration and their premise is that IT provides the underlying infrastructure to enable the integration. This kind of research model is promising because it will allow the researcher to understand the impact and role of RFID (at its most basic an IT infrastructure investment) in information, physical and perhaps even financial flow integration (e.g., coordinating payments with RFID assured delivery).

RFID like any other technology brings challenges together with benefits. Craighead and Shaw [2003] as well as Rai, Patnayakuni et al., [2004] propose a resource-based view of the supply chain in which it is possible to assess the “value” of the various IT and operational capabilities of the manufacturer and associated supply chain partners. IT can directly impact value by, for example, reducing costs or indirectly impact value by enhancing the firms’ capabilities (e.g., providing timely information that will eventually increase quality). Using the Craighead and Shaw or Rai et al. research model it may be possible to map and value the impact of RFID enabling an entire supply chain. Given the opportunity that RFID creates for all actors in a supply chain, it is likely a mistake to analyze costs and benefits within the context of a single firm. The models may also explain the real impact of Wal-Mart’s decree on its suppliers. In the short term, RFID will likely reduce value by directly negatively impacting the financial performance of suppliers (e.g., the costs of RFID compliance) and also indirectly damage the supplier (e.g., divert human resources to making sure the chips work). However, over time, RFID adoption may lead to value creation and enablement. Empirical research that can map the macro impact of RFID adoption on a large firm’s supply chain (and its partners and suppliers) will probably create new insights that can potentially change our theoretical and practical understanding.

### **DOES RFID MATTER? AND WHAT IS THE ROI?**

RFID is a technology that does more, at a higher cost, and is more complex than traditional bar coding. The adoption of RFID provides yet another opportunity to explore the age-old IT ROI question. A key pending question for many organizations is identifying when to go from pallet level tagging to item level tagging. An econometric model to assess item level tagging and simulations that can analyze scenarios will be useful to managers who are considering the factors involved in implementing item level tagging.

### **VII. CONCLUSIONS**

The advent of the Internet greatly enhanced the businesses’ ability to reach out to individuals and personalize products for the mass market. RFID further extends the reach of IT systems beyond networked computers to include devices with no inherent information processing capabilities. This quantum change could represent a strategic opportunity for business organizations. In industrial applications, RFID systems may translate into better quality control and enhanced data security. They can increase supply chain efficiency by providing improved stock management and increasing throughput. They can reduce labor costs. They can help reduce losses from inventory shrinkage and infiltration of counterfeit goods in the supply chain. In the company’s warehouses, RFID can improve receiving, picking, and shipping accuracies. In short, RFID is an enabling technology. It is entirely possible that the “killer app” is not yet implemented. When organizations adopt RFID to streamline their supply chain, they may envision new ways to achieve competitive advantage.

After the high-amplitude crest of RFID hyperbole and the relatively shallow trough of negativity, we are heading towards a dampened yet more realistic implementation of RFID. Many companies are moving cautiously toward adoption due to the absence of clear first-mover advantages, complexity of the technology and ROI concerns.

Given the current challenges of integration, interference, and other technology and implementation problems, a university can be an invaluable resource to local organizations by taking a leading role in testing and evaluation. For example, in establishing a testing laboratory at which organizations can see demonstrations and evaluate products and envision new applications. Many vendors and system integrators provide such laboratories; however, their agenda is different. The academic spirit of vendor-neutral evaluation can play a major role. Moreover, such laboratories can also help universities produce the trained personnel that organizations want to hire.

Like other information technologies, RFID will eventually carve a place for itself and may become widespread. What is important at this stage is to carefully catalogue the lessons learned by early adopters and make this knowledge available to would-be adopters and researchers. The role of researchers is to identify, evaluate, and propose solutions to issues in order to develop guidelines for deriving maximum benefits from the technology while avoiding its pitfalls. This paper is a small step in that direction because it provides:

- an in-depth analysis of the technology to a level normally not available in consulting reports (Section II),
- an integrated model that illustrates how RFID can be implemented in the supply chain (Section III),
- an applications framework to understand and envision applications (Section III),
- in-depth analysis of business implications (Section IV),
- a checklist for adoption (Section V), and
- specific suggestions for research (Section VI).

*Editor's Note:* This article was received on December 20, 2004 and was published on March 25, 2005. It was with the authors 2 weeks for one revision.

## REFERENCES

EDITOR'S NOTE: The following reference list contains the address of World Wide Web pages. Readers who have the ability to access the Web directly from their computer or are reading the paper on the Web, can gain direct access to these references. Readers are warned, however, that

1. these links existed as of the date of publication but are not guaranteed to be working thereafter.
2. the contents of Web pages may change over time. Where version information is provided in the References, different versions may not contain the information or the conclusions referenced.
3. the authors of the Web pages, not CAIS, are responsible for the accuracy of their content.
4. the author of this article, not CAIS, is responsible for the accuracy of the URL and version information.

Abbott, S. (2004). "RFID: How Far, How Fast: The Rest of the World" Deloitte Touche Tohmatsu.  
Acsis (2004). "RFID Integration: Lessons From The Front Line" Acsis

- Bednarz, A. (2004). "RFID everywhere: From amusement parks to blood supplies." *Network World*, (21)18, 1-2.
- Collins, J. (2004). "Alien Cuts Tag Price." *RFID Journal*, <http://216.121.131.129/article/articleprint/857/-1/1/> (January 2005)
- Craighead, C. W. and N. G. Shaw (2003). "E-Commerce Value Creation and Destruction: A Resource-Based Supply Chain Perspective." *The DATA BASE for Advances in Information Systems*, (34)2, 39 - 49.
- Dignan, L., J. DeAlmo, et al. (2004). "Will RFID completely change retailing and distribution?" *Irwin L. Gross eBusiness Institute Executive Breakfast, Temple University, Philadelphia, PA.*
- Dines, A. (2004). "Industry's First EPC-compliant, Real-time, Event Database." <http://www.businesswire.com> (September 20, 2004)
- Dipert, B. (2004). "Reading between the lines: RFIDs confront the venerable bar code." *EDN*, October 14, pg 48
- Harrop, P. and R. Das (2004). "Future of Chipless Smart Labels" IDTechEx
- Hovav, A., R. Patnayakuni, et al. (2004). "A Model of Internet Standards Adoption: The Case of IPv6." *Information Systems Journal*, (14)3, 265 - 294.
- Intermec (2004). "White Paper: Access Point Antenna Guide." [www.intermec.com](http://www.intermec.com).
- Jakovljevic, P. J. (2004). "RFID and Software Implications." *Technology Evaluations*, (April 22, 2004)
- Janz, B., M. Pitts, et al. (2005). "Back to the future with RFID: Lessons learned - Some Old, Some New." *Communications of AIS*, (15).
- Leach, P. T. (2004). "Inventory in Motion." *Journal of Commerce*, October 25, p. 29
- Lee, H. L. (2004). "The Triple-A Supply Chain." *Harvard Business Review*, October, 102 - 112
- Lee, H. L., V. Padmanabhan, et al. (1997). "The Bullwhip Effect in Supply Chains." *Sloan Management Review*, (Spring), 93 - 102.
- Mandviwalla, M., J. Confino, et al. (2004). "Radio Frequency Identification (RFID) in Practice". *Eastern Technology Council CIO Roundtable at ITEC, Valley Forge, PA.*
- Margulius, D. L. (2004). "The Rush to RFID." *InfoWorld*, April 09,
- Pick, J. (2004). "Geographic Information Systems: A Tutorial and Introduction." *Communications of AIS*, (14)16, 307 - 331.
- Rai, A., R. Patnayakuni, et al. (2004). "Firm Performance Impacts of Digitally-Enabled Supply Chain Integration Capabilities." *Georgia State University Working Paper.*
- RFID-Journal (2003). "New Energy-Efficient RFID Tag." *RFID journal*, <http://www.rfidjournal.com/article/articleview/718/1/1/> (Dec 25, 2004)
- Rockwell (2004). "RFID in Manufacturing." Rockwell Automation.
- ROI-Watch (2003). "ROI Watch." *Nucleus Research*, December 30,
- Rothfeder, J. (2004). "What's Wrong With RFID?" *CIO Insight*, (August 1).
- Sarma, S., S. Weis, et al. (2002). RFID systems: Security and Privacy implications. *Cryptographic Hardware and Embedded Systems -- CHES 2002*. C. Paar. Redwood Shores, CA, Springer-Verlag.
- SkyeTek (2004). "SkyeTek Announces World's Smallest RFID Reader." [http://www.skyetek.com/article\\_m1\\_mini.html](http://www.skyetek.com/article_m1_mini.html) (January 2005)
- Smart, L. (2004). "Making Sense of RFID." *netConnect*, (October 15), pg 4.
- Stegeman, L. (2004). "Who's Afraid of the Big Bad Wolf?" *Market Wire*, (Oct. 26).
- Stockman, H. (1948). "Communication by Means of Reflected Power". *Institute of Radio Engineers: IRE.*
- Straub, D., A. Rai, et al. (2004). "Measuring Firm Performance at the Network Level: A Nomology of the Business Impact of Digital Supply Networks." *Journal of Management Information Systems*, (21)1, pp 83 -115.
- sun.com (2003). "Sun and Auto-ID." [www.sun.com](http://www.sun.com) (September 2004)
- Takahashi, D. (2004). "The Father of RFID." *Mercury News* [www.siliconvalley.com](http://www.siliconvalley.com), [www.siliconvalley.com](http://www.siliconvalley.com) (November 23)
- Tegtmeier, L. A. (2004). "RFID Knowledge Enabled LOGISTICS." *Supply Chain Management*, (10)5, pg 24.



- Troyk, P. R. (1999). "Injectable Electronic Identification, Monitoring, and Stimulation Systems." *Annual Review of Biomedical Engineering*, (1)1, 177-210.
- Vernon, M. (2004). "Standards will Determine RFID's Success." *Computer Weekly*, June 29, pg 42
- Walker, J. (2004). "Commentary: The year of living RFID." *Forrester Research, CNET News.com*
- Watters, D. G., P. Jayaweera, et al. (2002). "Design and performance of wireless sensors for structural health monitoring." *AIP Conference Proceedings*, (615)1, 969-977.
- Weis, S. A., S. E. Sarma, et al. (2004). "Security and Privacy Aspects of Low-Cost Radio Frequency Identification Systems". *Security in Pervasive Computing: First International Conference*, Boppard, Germany: Springer-Verlag.
- Wilding, R. and T. Delgado (2004). "RFID Demystified." *Logistics & Transport Focus*, (6)5, 32-42.

## BIBLIOGRAPHY

- Anonymous (2000). "The case for 'smart' luggage." *Science Spectra*, pp. 12-14
- Anonymous (2001). "RFID system cuts time to locate items." *IIE Solutions*, (33)11, p. 15.
- Anonymous (2002). "Florida Airport Gets First RFID System." *IIE Solutions*, (34)7, p. 14.
- Anonymous (2002). "Streamer tracking system for the Veritas Vantage." *First Break (Blackwell Publishing Limited)*, (20)11, p. 667.
- Anonymous (2003). "Automotive Industry Drives the RFID Market." *Microwave Journal*, (46)11, p. 57.
- Anonymous (2003). "Human 'chipping' takes off." *Industrial Engineer: IE*, (35)12, p. 18.
- Anonymous (2003). "Security Friend and Foe." *Industrial Engineer: IE*, (35)11, 39-40.
- Anonymous (2004). "A Compact RFID Reader Platform for UHF and Microwave Applications." *Microwave Journal*, (47)4, 126-134.
- Anonymous (2004). "Group Reaffirms Support for Rapid Adoption of EPCglobal Standard." *Microwave Journal*, (47)6, 55-56.
- Anonymous (2004). "Philips and Checkpoint Commit to Delivering RFID Solutions." *Microwave Journal*, (47)7, p. 53.
- Anonymous (2004). "RFID benefits not universal." *Industrial Engineer: IE*, (36)2, p. 17.
- Anonymous (2004). "RFID Consultants Starting to Attack Vertical Markets." *Microwave Journal*, (47)10, p. 48.
- Anonymous (2004). "RFID Tag Market Up for Grabs." *Microwave Journal*, (47)8, 55-56.
- Anonymous (2004). "Tagging Toothpaste and Toddlers." *Information Management Journal*, (38)5, p. 22.
- Anonymous (2004). "Target mandates RFID." *Industrial Engineer: IE*, (36)5, p. 21.
- Chlamtac, I., C. Petrioli, et al. (1999). "Energy-Conserving Access Protocols for Identification Networks." *IEEE/ACM Transactions on Networking*, (7)1, 51-59.
- Elliott, M. (2003). "They had me at Prada." *Industrial Engineer: IE*, (35)11, p. 6.
- Faber, M. J. (2002). "RFID: The Next Tool for Managing Records?" *Information Management Journal*, (36)6, 60-62.
- Ferguson, G. T. (2002). "Have Your Objects Call My Objects." *Harvard Business Review*, (80)6, 138-143.
- Gao, J., C. L. Law, et al. (2003). "A submicron PHEMT nonlinear model suitable for RFID low current amplifier design." *International Journal of Electronics*, (90)7, 433-444.
- Hicks, P. (1999). "RFID and The Book Trade." *Publishing Research Quarterly*, (15)2, 21-23.
- Jaselskis, E. J., M. R. Anderson, et al. (1995). "Radio-Frequency Identification Applications in Construction Industry." *Journal of Construction Engineering & Management*, (121)2, 189-196.
- Kinsella, B. (2003). "THE Wal-Mart FACTOR." *Industrial Engineer: IE*, (35)11, 32-36.
- Lapide, L. (2004). "RFID: What's In It For The Forecaster?" *Journal of Business Forecasting Methods & Systems*, (23)2, 16-19.
- Mumford, R. (2004). "RFID Swings Into 2004 with High Hopes." *Microwave Journal*, (47)3, p. 49.
- Mumford, R. (2004). "A Smart Move as Philips and IBM Join Forces." *Microwave Journal*, (47)3, p. 45.



- Neelakanta, P. S., A. K. Stampalia, et al. (2003). "An Actively-Controlled Microwave Reflecting Surface with Binary-Pattern Modulation." *Microwave Journal*, (46)12, 22-36.
- Niemeyer, A., M. H. Pak, et al. (2003). "Smart tags for your supply chain." *McKinsey Quarterly*, 4, 6-9.
- Pope, D. (1997). "Radio ID Tags." *Industrial Physicist*, (3)1, p. 23.
- Rappold, J. (2003). "The Risks of RFID." *Industrial Engineer: IE*, (35)11, 37-38.
- Roebuck, W. (2004). "Transparent RFID." *IEE Review*, (50)5, p. 4.
- Saar, S. and V. Thomas (2002). "Toward Trash That Thinks: Product Tags for Environmental Management." *Journal of Industrial Ecology*, (6)2, 133-146.
- Sangani, K. (2004). "RFID Sees All." *IEE Review*, (50)4, 22-24.
- Smith, H. and B. Konsynski (2003). "Developments in Practice X: Radio Frequency Identification (RFID) - An Internet for Physical Objects." *Communications of AIS*, (2003)12, 301-311.
- Spiegel, R. (2004). "RFID Report." *Supply Chain Management Review*, June 29, pg 66
- Stapleton-Gray, R. (2004). "Vulnerable link in supply chain." *Armed Forces Journal International*, (141)10, 26-27.
- Thompson, C. A. (2004). "Radio Frequency Tags for Identifying Legitimate Drug Products Discussed by Tech Industry." *American Journal of Health-System Pharmacy*, (61)14, 1430-1431.
- Wadham, R. (2003). "Radio Frequency Identification." *Library Mosaics*, (14)5, P. 22.
- Wilding, R. and T. Delgado (2004). "RFID Demystified: Supply-Chain Applications." *Logistics & Transport Focus*, (6)4, 42-48.
- Wilding, R. and T. Delgado (2004). "The Story So Far: RFID Demystified." *Logistics & Transport Focus*, (6)3, 26-31.

## APPENDIX I. RESULTS OF A LABORATORY EXPERIMENT

A thorough search was conducted to find vendors offering evaluation kits. The vendors were then short-listed on the basis of cost and supporting documentation. Texas Instruments was selected because they offered lowest cost combined with good documentation and demonstration software. A micro-evaluation kit was purchased. It consisted of the following:

- A S2000 RFID reader with interface board and low Q-factor antenna
- Nine transponders, each with a different form factor
- Supporting documentation
- Demonstration software
- Serial cable

It was easy to setup the equipment, yet it did not work the first time. Support from TI was sought on telephone. They advised removing a jumper from the interface board, after which the reader started reading properly. The reader was attached to the COM1 port of a PC via the serial cable and demo program launched. The program got into a loop and started displaying error messages. Again TI support was contacted, which indicated that the software wouldn't work if the port were already open. Therefore the RFID reader was then attached to the COM2 port. This change solved the problem. A screenshot of this software is shown in Figure A-1.

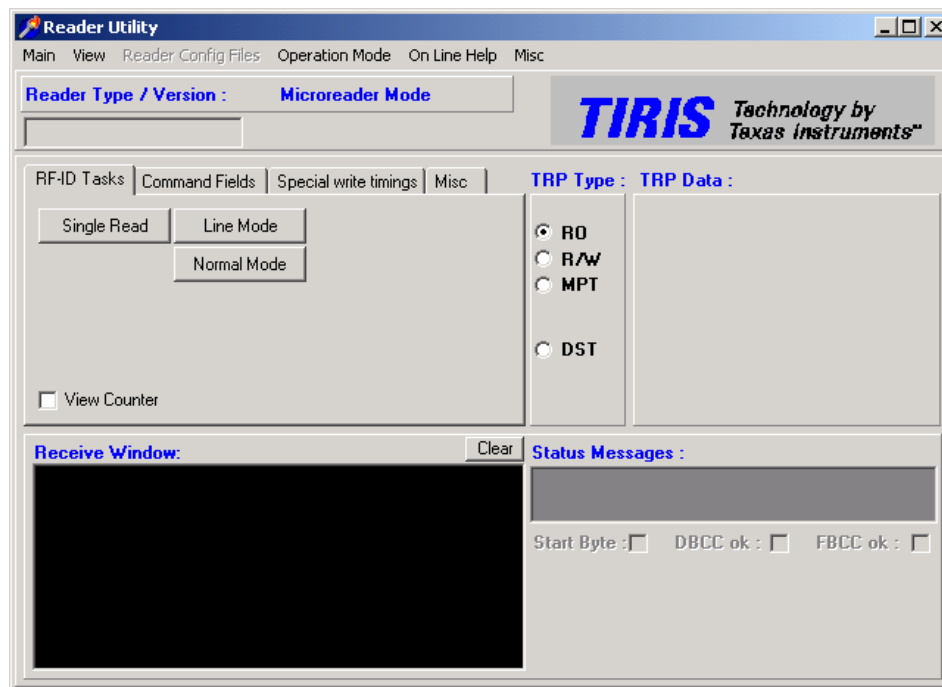

Figure A-1. Reader Utility

The View Menu provided options for configuring the software such as the baud rate, parity, and com port. The software also supported communication protocols for other Texas Instruments RFID readers such as series S6000. The communication protocol for the S2000 reader was selected from the Operation Mode menu. This mode displayed additional tabs such as for special write timings. Under the RFID Tasks tab, two options were available 'single read' and 'line mode'. In the latter mode, the reader utility kept displaying the contents of input buffer at very short intervals of time. In 'single read' mode data was displayed only when a tag was read. If the tag were of read/write type, the utility automatically switched to read/write mode. One of the tags was 'programmed' using this utility by changing its identifying serial code. It was noticed that the tags were actually write once/read many times.

However, it soon became clear that the demo program did not communicate with any other application. Hence it was impossible to capture the data read by the reader and use it for application purposes. TI support was contacted to explore the possibility of obtaining software that could interface between the reader and say an MS Access application. None was available. Therefore, it was decided to develop interfacing software in-house. Visual Basic 6 was selected as the language of choice on the basis of the researchers' familiarity with it. Since Texas Instruments provide only technical specifications for the S2000 reader, it became necessary to do low level programming, which makes use of the byte-level communication protocol given in the specifications. For this purpose, MSComm control was employed in the serial communication program. After several trials, a small utility program was developed that successfully communicated with the RFID reader. A screenshot of this utility is shown in Figure A-2.

Using this program several experiments were conducted to observe the effect of distance and direction on the range of various transponders. The transponders used were of the following types (Figure A-3)

- 85mm Read/Write Disk Transponder
- 30mm Read Only Disk Transponder

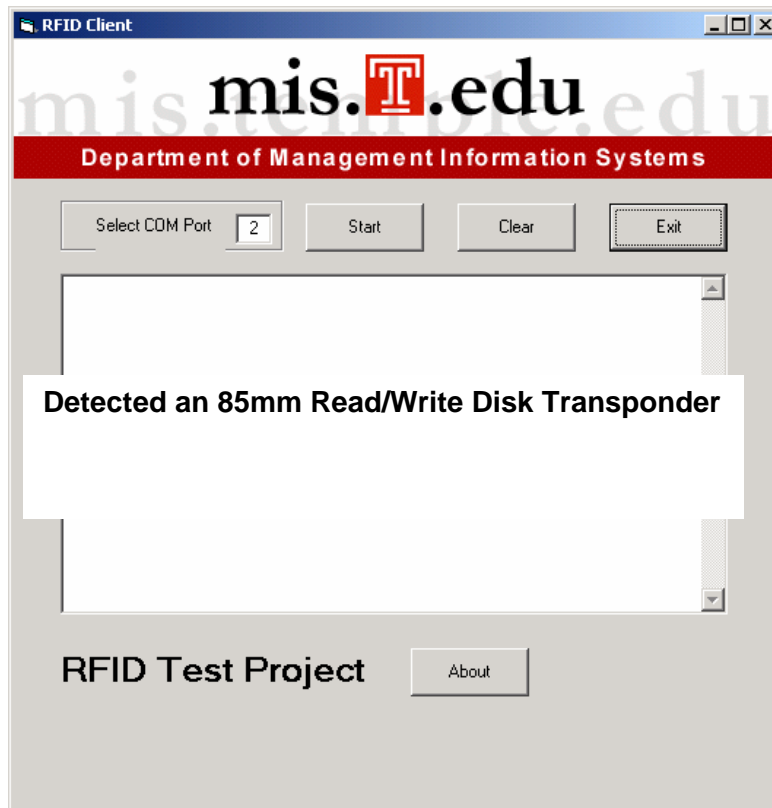
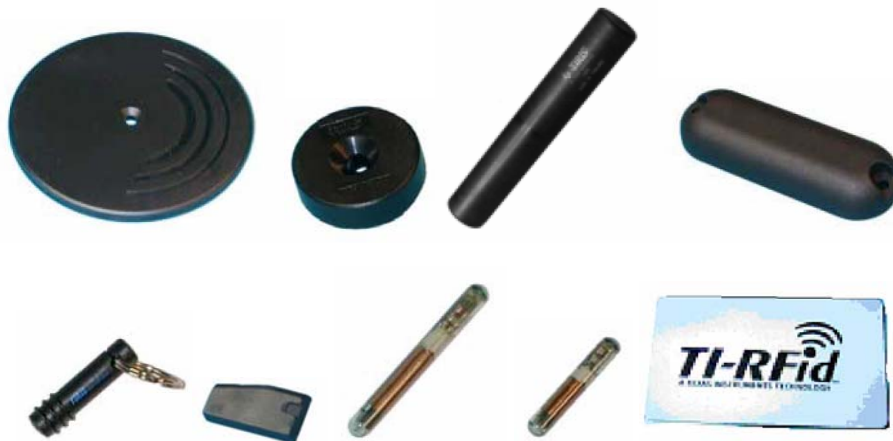

Figure A-2. RFID Test Software

- 120mm Read Only Cylindrical Transponder
- Read Only Mount-on-Metal Transponder
- Read Only Key ring Transponder
- 12mm Read Only Wedge Transponder
- 32mm Selective Addressable Multipage Glass Transponder
- 23mm Read Only Glass Transponder
- Read/Write Card Transponder



Not to Scale

Figure A-3. Tags Used in the Study

It was found that the range of these transponders fell between 2 and 18 inches (Figure A-4). This range was considerably less than the specified range which was from 8 to 80 inches. However, a footnote to the specifications indicated that these ranges are approximate and depend on various factors including the environmental conditions, the configuration of the reader antenna used and RF regulation in the country of use. All the tags used in experiments were of passive type. In the presence of metal objects, the range of tags dropped drastically. Ranges for cylinder and disk

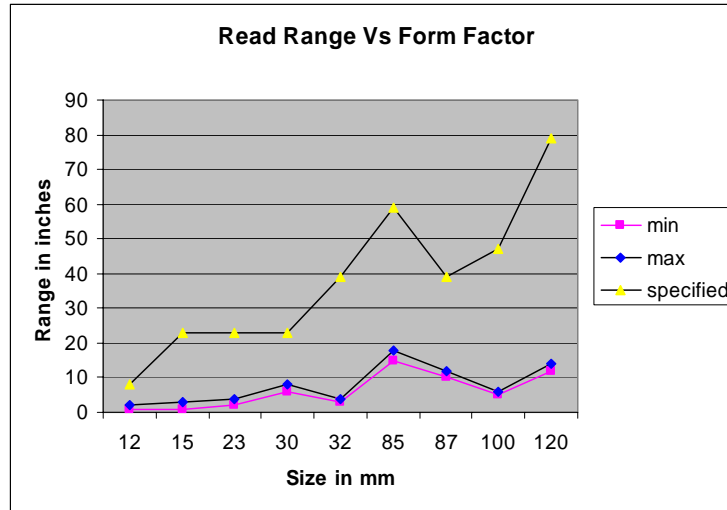

Figure A-4. Read Range versus Form Factor for Transponders

The reader worked satisfactorily in presence of radio interference which was generated by the PCs in the room. This radio noise was picked up by the reader and indicated by a yellow flashing LED on the interface board. However, when two or more tags were brought in the vicinity of the antenna at once, the reader simply ignored all of them, except when one of the tags was the 120mm cylindrical tag. In that case only the 120mm tag was read. This finding is easily explained by the longer read range of the cylindrical transponder. The read range of other transponders is shown in Figure A-4. It shows a rough correspondence of read range with the size of the tag. However, all ranges were considerably lower than their specified values.

In April 2004 Alien Technologies announced a 20 cent tag (Figure 1) for customers buying minimum of a million tags [Collins, 2004]. At lower quantities the prices are still extremely high as can be seen from Table A- 1.

Table A-1 Tag Costs

Tag	Unit Cost (minimum of 100 pieces)*
23mm Read Only Glass Transponder	\$ 3.26
32mm SAMP Glass Transponder	\$ 5.71
12mm Read Only Wedge Transponder	\$ 3.16
Read/Write Card Transponder	\$ 4.18
30mm Read Only Disk Transponder	\$ 4.24
Read Only Key ring Transponder	\$ 4.56
85mm Read/Write Disk Transponder	\$ 7.19
120mm Read Only Cylindrical Transponder	\$ 8.64
Read Only Mount-on-Metal Transponder	\$ 8.90

\* As of January 2005 for Texas Instruments

## APPENDIX II. VENDORS

The RFID industry may be segmented into hardware, software, system integration, printing, and services sectors. Table A-2 is a list of some of the leading firms in each sector. Note that some companies operate in more than one sector. Detailed contact information on these vendors can be obtained from web sites such as [www.rfidjournal.com](http://www.rfidjournal.com) or [www.managingautomaton.com](http://www.managingautomaton.com)

Table A-2. RFID Vendors

Organization	Major Expertise
Accenture	Services
Alien Technologies	Hardware
Canon Fintech	Label and Printers
Capgemini	Services
Checkpoint Software Technologies	Software
Datamax	Label and Printers
Deloitte	Services
DynaSys	Software
EDS	Services
HK Systems	Services
IBM	Services
IDTech	System Integrators
IDTechEX	Services
Impinj Inc.	Hardware
Intermec Technologies Corporation.	Software
Matrics	Software
Northern Apex	System Integrators
ODIN Technologies	System Integrators
Omron Auto ID Systems	Hardware
Philips Semiconductors	Hardware
Printronix	Label & Printers
RedPrairie	Software
SAP	Software
Savi Technologies	Hardware
SEEBURGER Business Integration	System Integrators
SUN Microsystems	Hardware
Symbol Technologies	Software
TAGSYS	Hardware
Texas Instruments	Hardware
ThingMagic	Hardware
Xident Technology	Label & Printers
Zebra Technologies	Software

## GLOSSARY<sup>4</sup>

**Addressability:** The storage capacity of a tag is divided up into a combination of read-only and read-write fields or blocks. The ability to address these fields for reading or writing purposes is called the tag's addressability.

**Air interface protocol:** The rules that determine how readers and tags communicate with each other.

<sup>4</sup> Adapted from RFIDjournal.com, eutelsat.com, webopedia.com and Vernon, M. (2004). "Standards will Determine RFID's Success." *Computer Weekly*, June 29, pg 42].

**Antenna gain:** The ability of an antenna to converge radio waves in a certain direction is measured by its gain. The gain of a theoretical antenna that radiates equally in all directions is 1, by definition, and is called an isotropic antenna. The gain of a real antenna is expressed relative to this theoretical antenna and is affected by the size of the antenna, its efficiency of focusing the radiation, and its operating frequency.

**Anti-collision:** The algorithm written to prevent radio waves from two adjacent devices or tags from interfering with each other. These algorithms are also used to read multiple tags in the same reader's field.

**Auto-ID center:** was established by MIT in 1999 to develop a conceptual framework for global supply chains integrated through the use of RFID technology and standardized item identification codes called the Electronic Product Code, or EPC. It was funded by many organizations including Uniform Code Council, EAN International, Procter & Gamble, and Gillette (now a part of Procter and Gamble). It was officially closed in 2003 after launching EPCglobal.

**Backscatter:** An RFID communication method in which a passive tag communicates with a reader by reflecting back radio waves beamed at it by the reader. The tag modulates the wave before reflecting it back to encode and transmit its data.

**Chipless RFID tag:** An RFID tag with only an antenna and no silicon microchip. Instead of a microchip, some chipless tags contain circuits of conducting polymers. Materials that can partially reflect back radio waves bombarded at them are also used in some other chipless RFID technologies.

**Concentrator:** Multiple RFID readers may be connected to a single host computer by using a special device known as a concentrator. The concentrator gathers data from all the readers connected to it, filters the data, and passes on only useful information to the host.

**Data read rate:** The number of tags that can be read within a given time interval.

**Data transfer rate:** The speed at which data is exchanged between a tag and a reader.

**EEPROM (Electrically Erasable Programmable Read-Only Memory):** A kind of non-volatile method of storing data on integrated circuits. Normally individual bytes can be wiped out and reprogrammed. Factory programmed chips, where the data is burnt into the chip when the chip is made, are cheaper than RFID tags having an EEPROM in them. However, EEPROM chips are more flexible because the end user can read, write, and re-write data as and when required.

**Electromagnetic interference (EMI):** Many electrical devices such as motors, conveyor belts, robots, or cell phones generate radio noise that can interfere with the clean signals from RFID tags and cause the performance of a reader to deteriorate.

**Electronic article surveillance (EAS):** A simple electronic tag that uses RF-based or acousto-magnetic technology that can be switched on or off to signal its presence. These tags are used mostly in retail stores and libraries to prevent shoplifting and theft. When a person walks past a detector with a still-on EAS tag an alarm goes off. The tag may be switched off at the time an item is purchased or borrowed.

**Electronic Product Code (EPC):** EPC is a 96-bit code identifying the individual item, the product category and the manufacturer. EPC is under development by the Uniform Code Council (UCC) as a standard.

**EPROM:** (pronounced ee-prom) EPROM stands for erasable programmable read-only memory. It is a special type of non-volatile read-write memory whose contents can be erased by exposure to ultraviolet light. Once erased it can be reprogrammed electrically.



**Error correcting code:** A number or a code computed according to certain algorithms that lets a reader detect and correct errors that might occur during a read operation. These codes are used to avoid situations where a reader mistakenly thinks a diamond ring to be a toothbrush.

**European Telecommunications Standards Institute (ETSI):** ETSI is an independent, non-profit organization responsible for standardization of broadcasting, telecommunications, and related areas such as medical electronics within Europe.

**European Article Numbering (EAN):** A UPC compatible bar code standard used across Europe, South America, and Asia. It is administered by Brussels based EAN International <http://www.ean-int.org/>.

**Federal Communications Commission (FCC):** The FCC is a US government agency that regulates wire, radio, satellite, cable, and television communications.

**Field programming:** The writing of data onto tags containing non-volatile memory such as an EEPROM, after they are shipped from the factory.

**Frequency:** The number of complete wave cycles per second. One Hertz (Hz) equals one cycle per second. One Kilo Hertz (1KHz) equals one thousand cycles per second.

**Frequency hopping:** An anti-collision technique used to prevent radio waves from adjacent readers from interfering with one another. RFID readers usually operate in a band of permissible frequencies rather than at a precise frequency value. The readers may jump from one frequency to another in a random or a programmed fashion within the lower and the upper limits of the band. The chances of two readers working at the exact same frequency is minimal for sufficiently wide bands.

**Industrial, Scientific, and Medical (ISM) bands:** A group of electromagnetic frequencies not requiring licensing commonly used for cordless phones and WiFi. These groups are :

- ISM-900 ranging from 902 to 928 MHz
- ISM-2.4 ranging from 2400 to 2483.5 MHz
- ISM-5.8 ranging from 5.725GHz to 5.850 GHz

Equipment which uses the ISM band must tolerate interference from other such equipment and must operate within certain maximum emitted power limits.

**Inlay:** Essentially the unfinished core of smart labels, inlays consist of a microchip attached to an antenna.

**Memory block:** The storage capacity of an RFID tag is usually broken into a set of fields that could be written to or read individually. It is possible to lock some of these fields permanently so that they can not be overwritten.

**Multiplexer:** With the help of an electronic device called a multiplexer, several antennas may be connected to a single reader. The reader employs a program to poll antennas in a sequence. This mechanism allows a wider area to be covered by a single reader and avoids antenna interference.

**Null spot:** At some points within a reader's field the radio waves may cancel each other out due to reflection and interference. Such 'blind spots' are quite common in UHF systems.

**Object Name Service (ONS):** It is a service that locates detailed information about an object stored on the Internet using the object's unique EPC. It works just like Domain Name Service (DNS) which locates web pages on the Internet using unique IP addresses.

**Orientation:** The relative alignment of a tag antenna and a reader antenna.

**Patch antenna:** A small solid metal or foil antenna, usually square in shape.

**Phantom read (a.k.a. a false read or phantom transaction):** When a tag that does not physically exist, erroneously appears on a reader's screen.

**Programming a tag:** Storing data on to an RFID tag. The term "commissioning a tag" is also sometimes used for this purpose.

**Read:** The process of energizing an RFID tag by beaming radio waves on it in order to read its data by decoding the waves sent back by the tag.

**Reader field:** The range in which tags can be read.

**Reader talks first:** A method of communications between passive tags and their reader. The tags are energized by the reader but do not respond until asked by the reader. In this way a reader can isolate a specific tag by using algorithms such as 'tree walking' (also called singulation).

**Singulation:** A group of methods by means of which a reader can single out a tag having a specific serial number. Suppose the reader is looking for a tag with a serial number 10110011... . The reader starts by asking all tags whose serial number start with a '1' to respond. If more than one tags respond, the reader then asks all tags with serial numbers starting with '10' to respond and then '101' and so on. This method is known as 'tree walking'.

**SAW (Surface Acoustic Wave):** SAW is an identification method in which RF waves are converted into ultrasonic acoustic waves by a piezoelectric crystal mounted on the surface of a tag.

**Tag talks first:** In this UHF mode of communication between passive tags and their readers, the tags start transmitting their data as soon as they enter a reader's field. This mode is useful for tracking fast moving objects.

**WORM:** Write once, read many. A type of memory that can be written only once but read multiple times thereafter.

**XML Query Language (XQL):** An (extensible markup language) XML-based, non-procedural query language used to search a networked database.

## ABOUT THE AUTHORS

**Zaheeruddin Asif** holds an MBA in Management Information Systems and a Post Graduate Diploma in Systems Analysis and Design from Institute of Business Administration (IBA), University of Karachi, Pakistan. He also holds an undergraduate double degree in Mathematics and Physics. He worked for IBM and Toyota before joining IBA, where he lectured on IS management and database administration. He also conducted research for Central Board of Revenue, Export Promotion Bureau, Pakistan Software Export Board, and Pakistan Ordinance Factories in the areas of Business Process Reengineering, Enterprise Resource Planning and Systems Analysis & Design. He is currently pursuing his PhD in Management Information Systems from Fox School of Business and Management at Temple University, Philadelphia PA.

**Munir Mandviwalla** is founding chair of the Management Information Systems department, and Executive Director, Irwin L. Gross eBusiness Institute, Fox School of Business and Management, at Temple University. He holds a BSc in Systems Engineering from Boston University, a MBA from the Peter F. Drucker School of Management at Claremont Graduate University, and a Ph.D. in MIS also from Claremont Graduate University. His research interests include collaborative systems, electronic commerce strategy, and the use of prototyping for theory development. Dr.

Mandviwalla is the author of more than 40 articles. His work has been supported by grants of more than \$2 Million from NSF, IBM, Microsoft, CIGNA, Advanta, Lotus, and Lilly Endowment. In 2000, IBM selected him for their Faculty Partnership Award. In 2002, The Claremont Graduate University recognized him with their Alumni Hall of Fame award.

Copyright © 2005 by the Association for Information Systems. Permission to make digital or hard copies of all or part of this work for personal or classroom use is granted without fee provided that copies are not made or distributed for profit or commercial advantage and that copies bear this notice and full citation on the first page. Copyright for components of this work owned by others than the Association for Information Systems must be honored. Abstracting with credit is permitted. To copy otherwise, to republish, to post on servers, or to redistribute to lists requires prior specific permission and/or fee. Request permission to publish from: AIS Administrative Office, P.O. Box 2712 Atlanta, GA, 30301-2712 Attn: Reprints or via e-mail from [ais@aisnet.org](mailto:ais@aisnet.org)



# Communications of the Association for Information Systems

ISSN: 1529-3181

## EDITOR-IN-CHIEF

Paul Gray  
Claremont Graduate University

## AIS SENIOR EDITORIAL BOARD

Detmar Straub Vice President Publications Georgia State University	Paul Gray Editor, CAIS Claremont Graduate University	Sirkka Jarvenpaa Editor, JAIS University of Texas at Austin
Edward A. Stohr Editor-at-Large Stevens Inst. of Technology	Blake Ives Editor, Electronic Publications University of Houston	Reagan Ramsower Editor, ISWorld Net Baylor University

## CAIS ADVISORY BOARD

Gordon Davis University of Minnesota	Ken Kraemer Univ. of Calif. at Irvine	M.Lynne Markus Bentley College	Richard Mason Southern Methodist Univ.
Jay Nunamaker University of Arizona	Henk Sol Delft University	Ralph Sprague University of Hawaii	Hugh J. Watson University of Georgia

## CAIS SENIOR EDITORS

Steve Alter U. of San Francisco	Chris Holland Manchester Bus. School	Jaak Jurison Fordham University	Jerry Luftman Stevens Inst. of Technology
------------------------------------	---	------------------------------------	--

## CAIS EDITORIAL BOARD

Tung Bui University of Hawaii	Fred Davis U. of Arkansas, Fayetteville	Candace Deans University of Richmond	Donna Dufner U. of Nebraska - Omaha
Omar El Sawy Univ. of Southern Calif.	Ali Farhoomand University of Hong Kong	Jane Fedorowicz Bentley College	Brent Gallupe Queens University
Robert L. Glass Computing Trends	Sy Goodman Ga. Inst. of Technology	Joze Gricar University of Maribor	Ake Gronlund University of Umea,
Ruth Guthrie California State Univ.	Alan Hevner Univ. of South Florida	Juhani Iivari Univ. of Oulu	Claudia Loebbecke University of Cologne
Munir Mandviwalla Temple University	Sal March Vanderbilt University	Don McCubbrey University of Denver	Emmanuel Monod University of Nantes
Michael Myers University of Auckland	Seev Neumann Tel Aviv University	Dan Power University of No. Iowa	Ram Ramesh SUNY-Buffalo
Kelley Rainer Auburn University	Paul Tallon Boston College	Thompson Teo Natl. U. of Singapore	Doug Vogel City Univ. of Hong Kong
Rolf Wigand U. of Arkansas, Little Rock	Upkar Varshney Georgia State Univ.	Vance Wilson U. of Wisconsin, Milwaukee	Peter Wolcott U. of Nebraska-Omaha
Ping Zhang Syracuse University			

## DEPARTMENTS

Global Diffusion of the Internet.  
Editors: Peter Wolcott and Sy Goodman  
Papers in French  
Editor: Emmanuel Monod

Information Technology and Systems.  
Editors: Alan Hevner and Sal March  
Information Systems and Healthcare  
Editor: Vance Wilson

## ADMINISTRATIVE PERSONNEL

Eph McLean AIS, Executive Director Georgia State University	Reagan Ramsower Publisher, CAIS Baylor University
---	---